

# Raphael

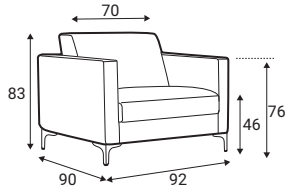

## Standard sets



1S - seater

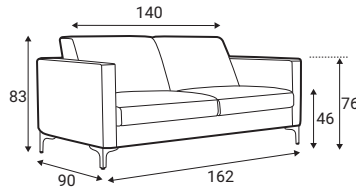

2S - seater

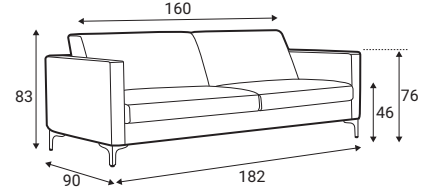

2.5S - seater

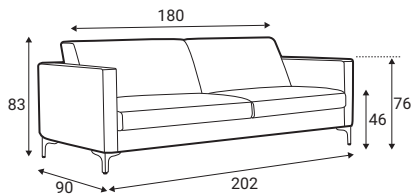

3S - seater

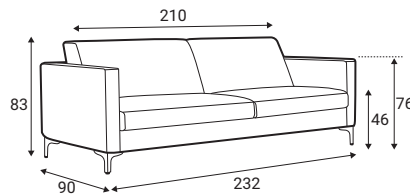

3.5S - seater

## Comfort

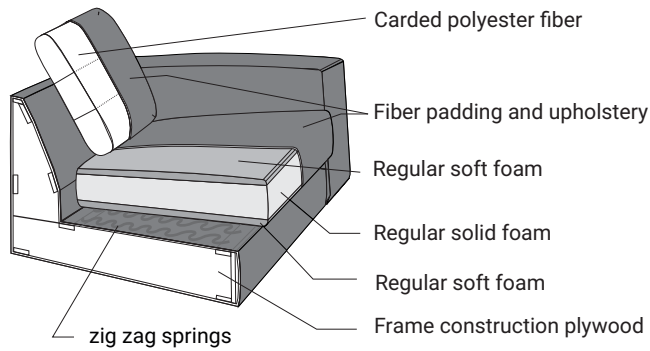

## Extra dimensions

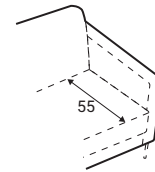

depth of seat

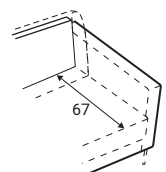

depth of seat without back cushions

## Legs



Leg WM04, H-170  
Black/Wenge

### Technical Description Frame

The Frames are made from Solid Pine and Plywood.

### Seat Frame

Base frame is mounted with Nosag Zig Zag Springs.

### Cushions

Base cushions are constructed with fire retardant foam and the back cushions are Carded Fiber.

### Fire Retardant

All Fabric and Foam are Fire Retardant.

